



工種：水閘工  
細別：BF掘削状況



工種：水閘工  
細別：人力床均し状況



工種：水閘工  
細別：掘削完了



工種：水閘工  
細別：水閘布設完了



工種：水閘工  
細別：防食テープ巻立完了



工種：水閘工  
細別：チーズ 75×75  
異径ソケット 75×50



工種：集水渠工  
細別：BF掘削状況



工種：集水渠工  
細別：人力床均し状況



工種：集水渠工  
細別：掘削完了



工種：集水渠工  
細別：集水管布設完了



工種：集水渠工  
細別：チ-ズ 75×50



工種：集水渠工  
細別：チ-ズ 75×50



工種：集水渠工  
細別：エルボ 50×90°

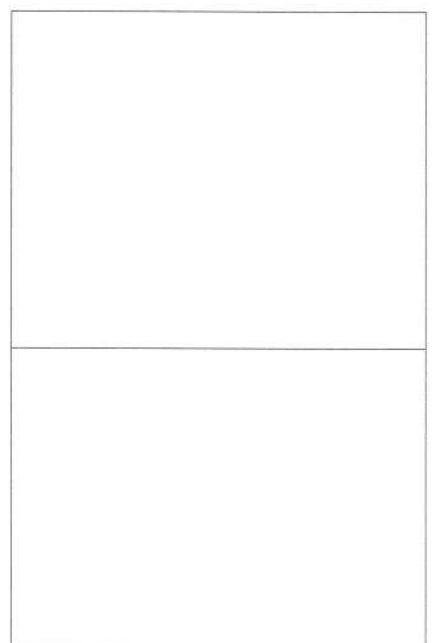
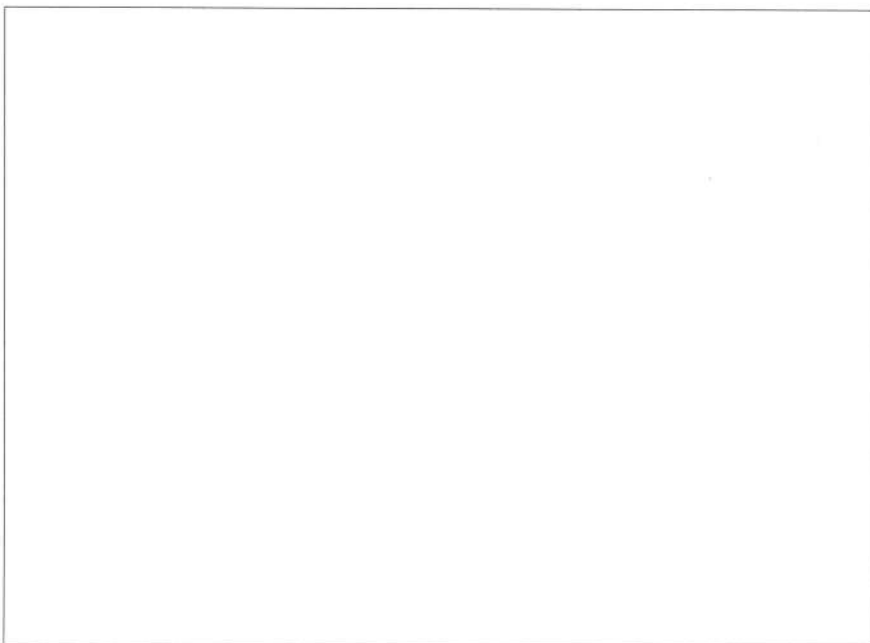
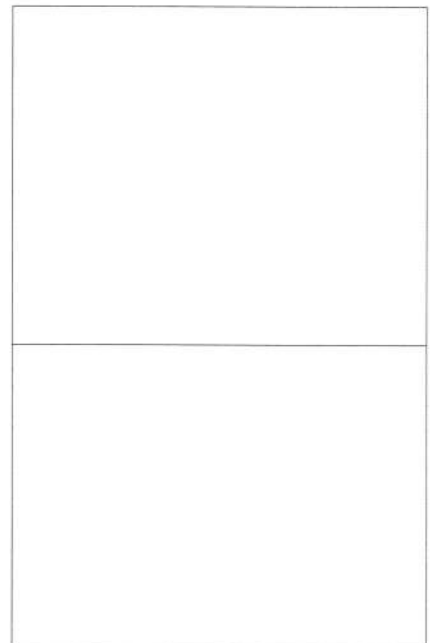
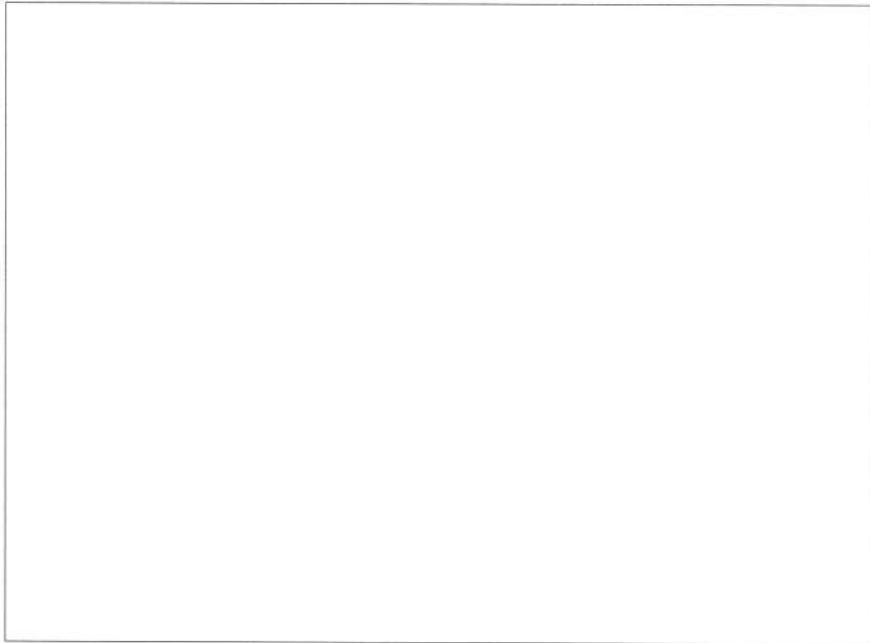



工種：吸水渠工  
細別：モミガラ積込み状況



工種：吸水渠工  
細別：吸水管布設状況



工種：吸水渠工  
細別：モミガラ布設状況



工種：吸水渠工  
細別：モミガラ転圧状況



工種：吸水渠工  
細別：発進口吸水管布設状況



工種：吸水渠工  
細別：発進口  
モミガラ布設状況



工種：吸水渠工  
細別：布設高管理状況  
(発光器)

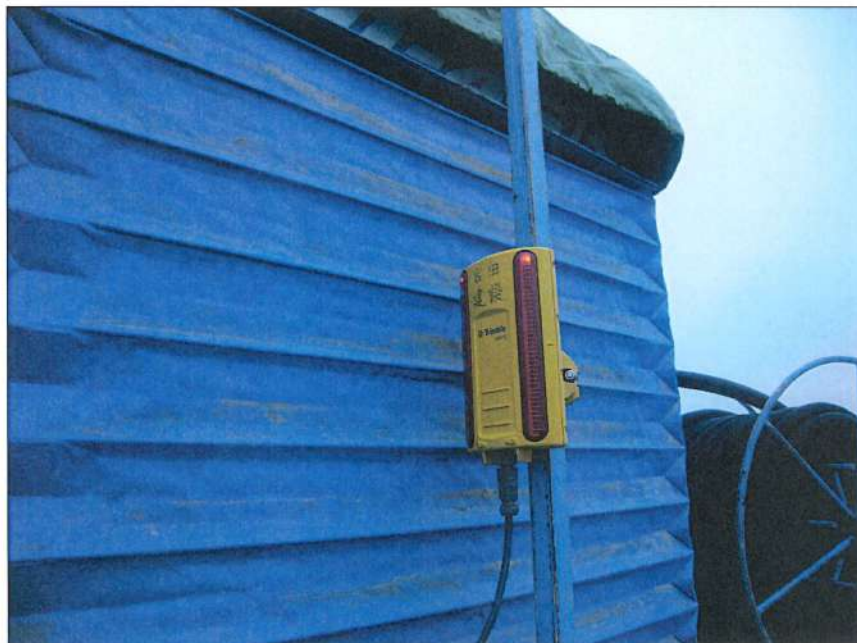

工種：吸水渠工  
細別：受光器



工種：吸水渠工  
細別：表示器





工種	吸水渠工
種別	下流
細別	吸水渠工出来形測定
施工管理値	設計 実測
H1	700
H2	520

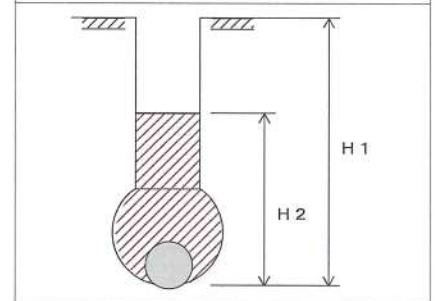

工種	吸水渠工
種別	下流
細別	部分拡大

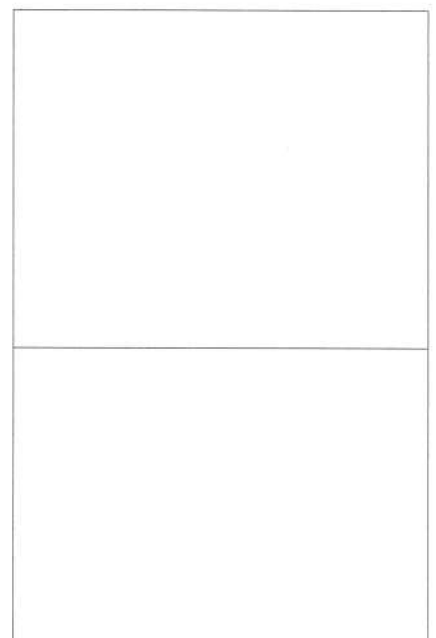
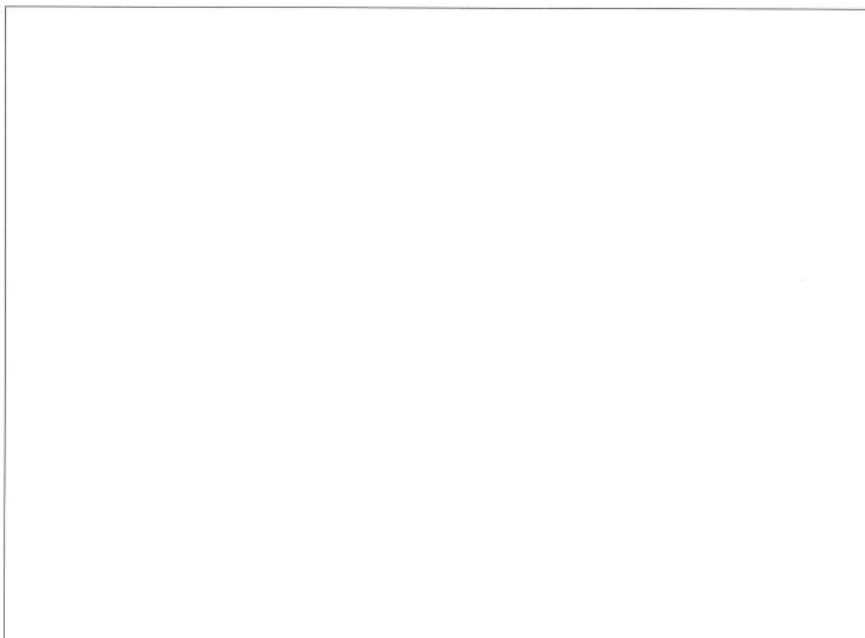



工種：吸水渠工  
 種別：中流  
 細別：吸水渠工出来形測定  
 施工管理値：  
 設計 実測  
 H1 600  
 H2 500

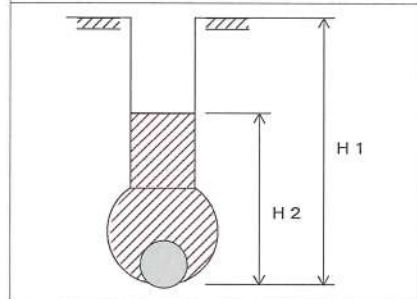

工種：吸水渠工  
 種別：中流  
 細別：部分拡大

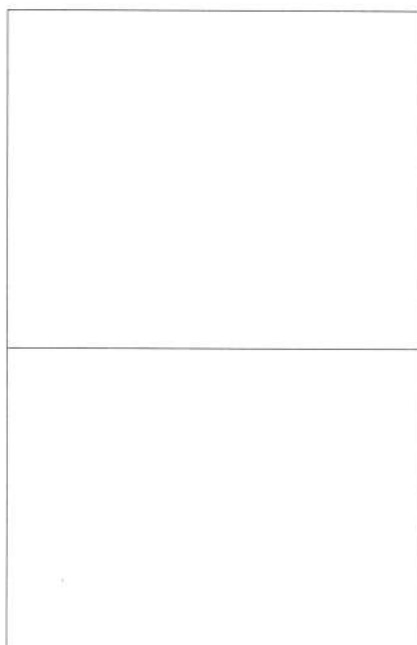



工種：吸水渠工  
 種別：上流  
 細別：吸水渠工出来形測定  
 施工管理値：  
 設計 実測  
 H1 500  
 H2 450

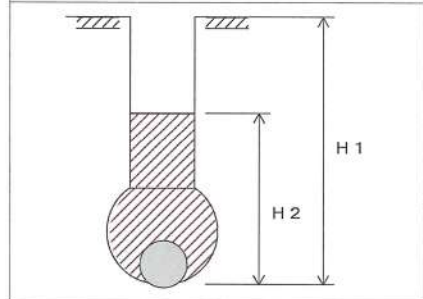

工種：吸水渠工  
 種別：上流  
 細別：部分拡大

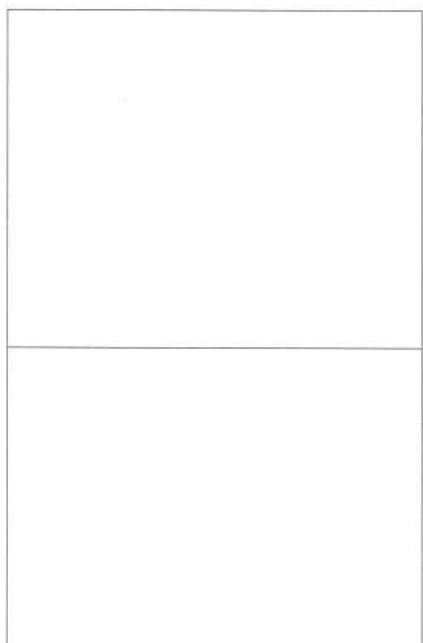
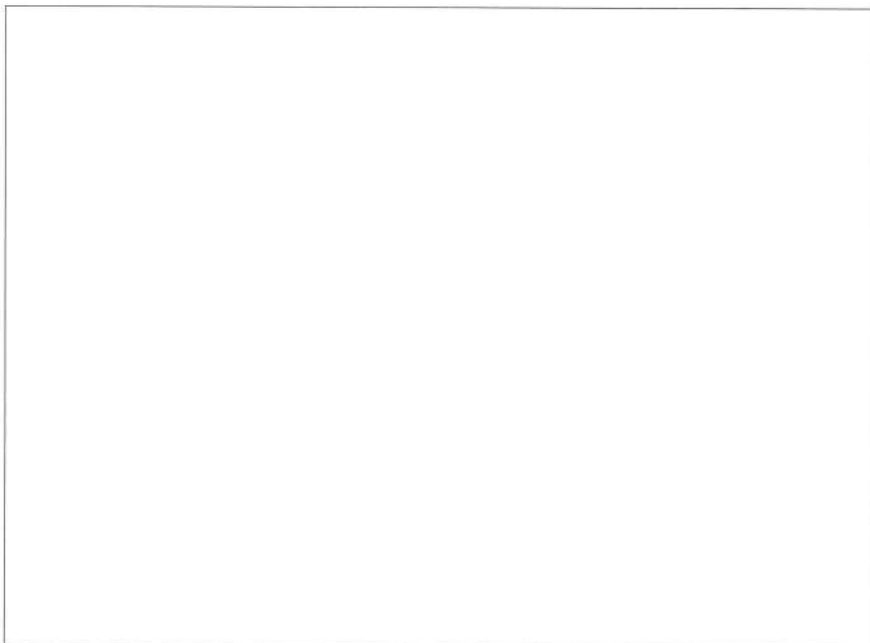



工種：吸水渠工  
細別：流出状況確認

